



GV200-60

Solar Charge and Discharge Controller User Manual



Model	GV200-60
Battery Voltage	12V/24V/36V/48V
Maximum Panel Voltage	200V
Maximum Input Power	850W/12V; 1680W/24V; 2500W/36V; 3400W/48V
Charging Current	60A
Discharging Current	25A

Dear User:

Thank you very much for choosing our product!

Safety Instructions:

1. Since the voltage of this controller exceeds the safe voltage range for the human body, please read the manual thoroughly and complete safety operation training before operating the controller.

2. There are no user-serviceable or maintainable parts inside the controller; do not attempt to disassemble or repair the controller yourself.

3. Install the controller indoors to avoid exposing components and prevent water from entering the unit.

4. Install the controller in a well-ventilated area, as the heat sink will become very hot during operation.

5. It is recommended to install appropriate fuses or circuit breakers outside the controller.

6. Before installing or adjusting the controller's wiring, disconnect the photovoltaic array and the fuses or circuit breakers near the battery terminals.

 **Warning:** Indicates that the operation is dangerous; ensure all safety preparations are made before proceeding.

 **Caution:** Indicates that the operation may cause damage.

 **Note:** Provides advice and tips for the operator.

Table of Contents

1 Product Overview	4
1.1 Product Features.....	5
1.2 Appearance and Interfaces.....	6
1.3 MPPT Technology.....	7
1.4 Charging Process Control.....	8
2 Technical Specifications	10
2.1 Electrical Parameters.....	10
2.2 Default Parameters for Battery Type.....	11
3 Protection Functions	12
4 Product Installation	13
4.1 Product Dimensions.....	13
4.2 Precautions.....	13
4.3 Wiring Specifications.....	14
4.4 Installation Steps.....	14
5 Interface Operation	17
5.1 LED Indicators.....	17
5.2 Button Operation.....	18
5.3 LCD Display and Operation.....	18
5.3.1 Main Page.....	18
5.3.2 Main Menu.....	19
5.3.3 Realtime Monitor.....	20
5.3.4 Parameter Settings.....	21
5.3.5 Event Logging.....	24
5.3.6 Historical Data.....	25
5.3.7 Statistical Data.....	26
5.3.8 Device Information.....	27
6 System Maintenance	29

1 Product Overview

This product supports Maximum Power Point Tracking (MPPT) technology, which enables tracking the maximum power point of solar panels accurately and quickly under any operating conditions. It ensures real-time acquisition of the maximum energy from the solar panels, significantly improving the energy utilization of the solar system. The product is widely used as a core control component in off-grid photovoltaic systems, managing and coordinating the operation of solar panels, batteries, and loads.

The product supports charging and discharging control for various lead-acid and lithium batteries, and features comprehensive software and hardware fault detection and protection functions. This minimizes the risk of damage to the photovoltaic panels, batteries, loads, and the controller itself due to installation errors, usage mistakes, or system faults.

The product features a graphical LCD display with a user-friendly interface, making it intuitive and convenient to use.

It supports multiple load control modes for user convenience.

The product is equipped with built-in fieldbus interface (Modbus RTU) and IoT communication interfaces (WiFi and BLE), providing native cloud platform access capabilities for easy management and usage.

1.1 Product Features

- MPPT technology can significantly improve the energy utilization of photovoltaic systems, with an efficiency increase of 15% to 20% compared to traditional PWM charging. The tracking efficiency of MPPT can reach up to 99.9%.
- Utilizing advanced digital power technology, the circuit energy conversion efficiency can reach up to 98%.
- Supports charging and discharging control for various types of batteries, including gel lead-acid batteries, sealed lead-acid batteries, flooded lead-acid batteries, lithium batteries, and user-defined types; also supports automatic battery voltage detection.
- Supports instantaneous high current startup for capacitive loads up to 10,000 μ F.
- Graphical LCD display with menu-based operation, providing intuitive and convenient parameter settings.
- Supports 256 event records and stores 1,024 days of historical data.
- Supports the standard Modbus RTU protocol to meet communication needs in various scenarios.
- Features temperature compensation, automatically adjusting charging and discharging parameters to extend battery life.
- Equipped with multiple protection functions to comprehensively safeguard the solar panels, batteries, loads, and the controller itself.
- Supports various load operating modes, including always-on, light-controlled, light-timed, manual control, and debugging mode.
- Equipped with built-in Bluetooth and WiFi interfaces, providing native cloud platform access capabilities. After connection, it can automatically synchronize the time.

1.2 Appearance and Interfaces

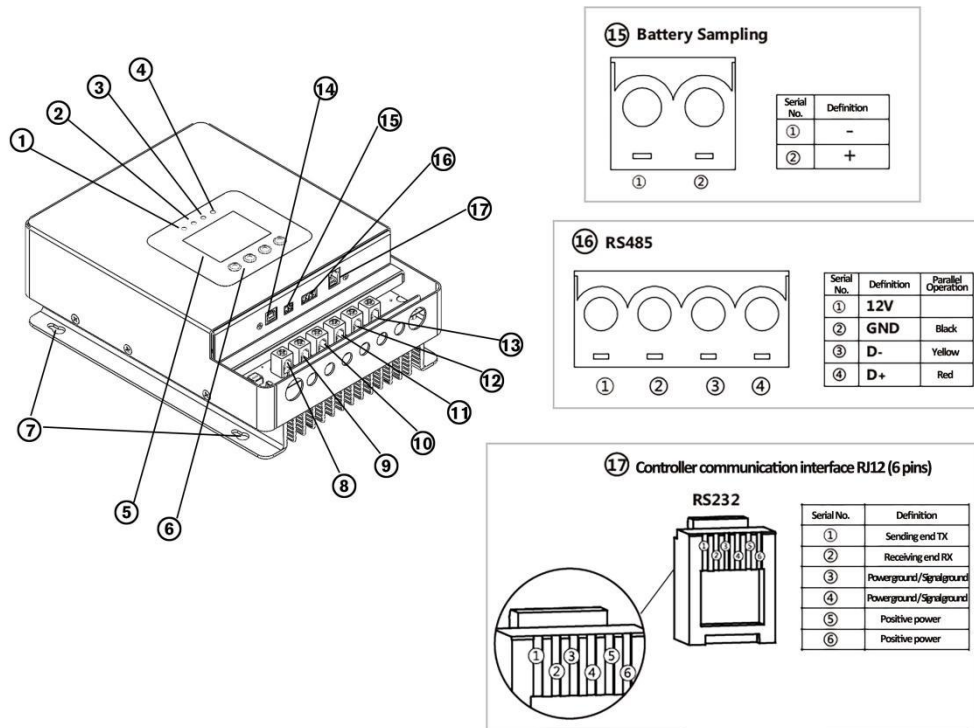

Figure 1-1 Appearance and Interfaces

Serial Number	Name	Serial Number	Name
①	Charging Indicator Light	⑩	Battery "-" Terminal
②	Battery Indicator Light	⑪	Load "-" Terminal
③	Load Indicator Light	⑫	Battery "+" Terminal
④	Fault Indicator Light	⑬	Load "+" Terminal
⑤	LCD Display	⑭	USB Programming Interface
⑥	Operation Button	⑮	External Temperature Sensing Interface
⑦	Mounting Hole	⑯	RS485 Communication Interface
⑧	Panel "+" Terminal	⑰	RS232 Communication Interface
⑨	Panel "+" Terminal		

1.3 MPPT Technology

Maximum Power Point Tracking (MPPT) systems are advanced charging technologies that adjust the operating state of electrical modules to enable solar panels to output more electrical energy. Due to the nonlinear characteristics of solar arrays, there is a maximum power point (MPP) on their characteristic curve where the array produces the highest energy output. Traditional controllers, such as those using switch-mode charging or PWM charging technology, cannot maintain operation at this point to charge the battery, and thus cannot extract the maximum energy from the solar panels. However, solar controllers equipped with MPPT technology can continuously track the array's maximum power point to obtain the highest energy and charge the battery accordingly.

For example, in a 12V system: when the peak voltage (V_{mp}) of the solar panel is around 17V and the battery voltage is around 12V, conventional charge controllers typically do not fully utilize the maximum power. MPPT controllers can overcome this issue by continuously adjusting the input voltage and current of the solar panel to extract the maximum input power from the solar energy.

Compared to traditional PWM controllers, MPPT controllers can increase energy utilization by 15% to 20%.

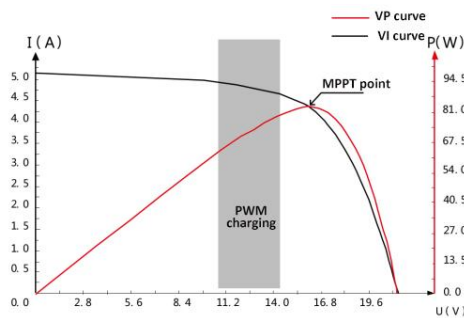

Figure 1-2: Solar Panel Output Characteristic Curve

Additionally, due to variations in environmental temperature and light conditions, the maximum power point frequently changes. This product can continuously adjust parameters according to different conditions to ensure that the system remains close to the maximum power point. The entire process is fully automatic and requires no user adjustment.

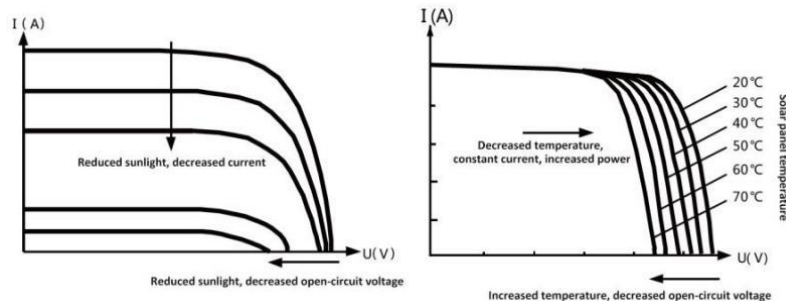

Figure 1-3: Relationship Between Solar Panel Output Characteristics and Illumination

Figure 1-4: Relationship Between Solar Panel Output Characteristics and Temperature

1.4 Charging Process Control

MPPT, as a stage of charging, cannot be used alone; it typically needs to be combined with other charging methods such as boost charging, float charging, and equalization charging to fully charge the battery. A complete charging process includes: fast charging, maintenance charging, and float charging. The charging curve is shown in the following diagram:

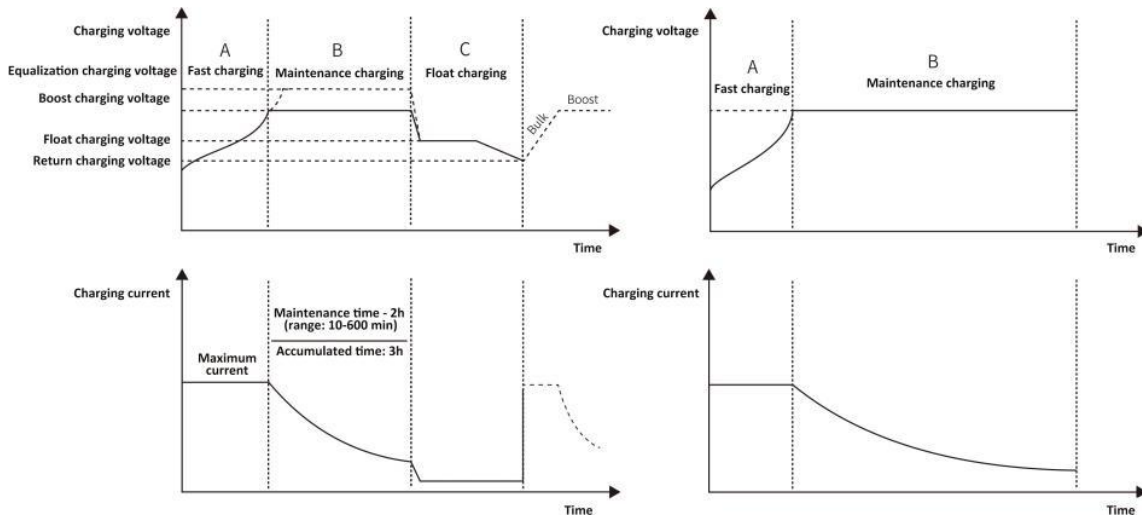

Figure 1-5: Schematic Diagram of Lead-Acid Battery Charging Stages

Figure 1-6: Schematic Diagram of Lithium Battery Charging Stages

■ Fast Charging

During the fast charging stage, when the battery voltage has not yet reached the set value for full charge (i.e., equalization/boost voltage), the controller performs MPPT charging to provide the maximum solar energy to the battery. Once the battery voltage reaches the preset value, constant voltage charging will begin.

■ Maintenance Charging

When the battery voltage reaches the set value for maintenance charging, the controller will switch to constant voltage charging. During this process, MPPT charging will no longer be used, and the charging current will gradually decrease over time. Maintenance charging consists of two stages: equalization charging and boost charging. These two charging processes do not repeat, with equalization charging occurring once every 30 days.

(1) Boost Charging

The boost charging stage typically has a default duration of 2 hours, but customers can adjust the maintenance time and boost voltage set point according to their needs. Once the duration reaches the set value, the system will transition to float charging.

(2) Equalization Charging

ⓘ **Warning: Risk of Explosion!**

Equalization charging of flooded lead-acid batteries can produce explosive gases, so the battery compartment must be well-ventilated.

⚠ **Warning: Equipment Damage!**

Equalization charging can increase the battery voltage to levels that may damage

sensitive DC loads. It is necessary to verify that all system loads have input voltage tolerances greater than the battery equalization charging setpoint.

⚠ Caution: Equipment Damage!

Overcharging and excessive gas evolution may damage the battery plates and cause the active material on the battery plates to detach. Excessive or prolonged equalization charging may cause damage. Please carefully review the specific requirements for the batteries used in your system.

Certain types of batteries benefit from periodic equalization charging, which stirs the electrolyte, balances the battery voltage, and completes chemical reactions. Equalization charging raises the battery voltage above the standard float voltage, causing the battery electrolyte to gasify. The default duration for equalization charging is 120 minutes. Equalization charging and boost charging are not repeated within a single charging cycle to avoid excessive gas evolution or battery overheating.

⚠ Caution: If the controller's clock is not calibrated, the controller will perform periodic equalization charging based on its internal clock.

■ Float Charging

Float charging occurs after the maintenance charging phase. The controller reduces the charging current to lower the battery voltage and maintains it at the float charging voltage setpoint. During the float charging phase, the battery is charged at a very low rate to ensure it remains at full capacity. In this phase, the load can utilize almost all of the solar energy available. If the load exceeds the energy provided by the solar panels, the controller will not be able to maintain the battery voltage in the float charging phase. When the battery voltage drops to the boost recovery charging setpoint, the system will exit the float charging phase and re-enter the fast charging phase.

2 Technical Specifications

2.1 Electrical Parameters

Parameter Name	Parameter Value
Model	GV200-60
Battery Parameters	
Supported Battery Types	SLD/GEL/FLD/LI/USE
Battery Rated Voltage	12V/24V/36V/48V Auto
Battery Voltage	9V~65V
Maximum Charging Current	60A
Temperature Compensation Coefficient	-3mv/°C/2V (Default Value)
PV Parameters	
Maximum Input Voltage	200V(195V Protection, 190V Recovery)
Maximum Input Current	50A
Vmp	17V~160V/12V; 36V~160V/24V; 55V~160V/36V; 70~160V/48V;
Maximum Input Power	850W/12V ; 1680W/24V; 2500W/36V ; 3400W/48V
Maximum Power Point Voltage Range	(Battery Voltage+2V) ~ 160V
MPPT Tracking Efficiency	>99%
Conversion Parameters	
Conversion Efficiency	85%~98%(10%~100% of Rated Power)
Load Parameters	
Rated Load Current	25A
Maximum Capacitive Load Capacity	10000uF
Load Operating Mode	Pure Light Control, Light Time Control, Manual Mode (Default), Debug Mode, Always On
Protection Settings	
Protection Functions	PV Overvoltage Protection, PV Reverse Polarity Protection, PV Overpower Protection, Nighttime Anti-Reverse Charging Protection, Controller Overtemperature Protection, Load Short Circuit Protection, Load Overload Protection, Battery Overvoltage/Overdischarge Protection, Battery Reverse Polarity Protection, Battery Overtemperature Protection, TVS Surge Protection
Device Parameters	
No-Load Loss	<0.5W
Operating Temperature	-10°C~+55°C
Waterproof Rating	IP20
Weight	3.6kg
Communication Method	RS232, RS485, WiFi, Bluetooth
Altitude	≤ 3000m
Product Dimensions	280x206x106.5mm
Cooling Method	Natural Cooling
Historical Data	Can store 256 event records and 1024 days of historical data.

2.2 Default Parameters for Battery Type

Set Voltage	Sealed Lead Acid (SLD)	Gel Lead Acid (GEL)	Flooded Lead Acid (FLD)	Lithium Battery (Li)	Custom (USE)
Overvoltage Disconnect Voltage	16.0V	16.0V	16.0V	—	9~17V
Equalization Voltage	14.6V	—	14.8V	—	9~17V
Boost Voltage	14.4V	14.2V	14.6V	14.4V	9~17V
Float Voltage	13.8V	13.8V	13.8V	—	9~17V
Boost Recovery Voltage	13.2V	13.2V	13.2V	—	9~17V
Low Voltage Disconnect Recovery Voltage	12.6V	12.6V	12.6V	12.6V	9~17V
Undervoltage Alarm Voltage	12.0V	12.0V	12.0V	—	9~17V
Low Voltage Disconnect Voltage	11.1V	11.1V	11.1V	11.1V	9~17V
Discharge Limit Voltage	10.6V	10.6V	10.6V	—	9~17V
Overdischarge Delay Time	5s	5s	5s	—	1~30s
Overdischarge Delay Time	120min	—	120min	—	0~300min
Equalization Charging Interval	30day	0day	30day	—	0~300day (0Indicates disabling the equalization charging function)
Boost Duration	120min	120min	120min	—	0~300min

When using a custom battery type, the system's default voltage parameters are consistent with those of sealed lead-acid batteries. When modifying the battery charge and discharge parameters, the following logic must be followed:

- Overvoltage Disconnect Voltage > Charge Limit Voltage \geq Equalization Voltage \geq Boost Voltage \geq Float Voltage > Boost Recovery Voltage;
- Overvoltage Disconnect Voltage > Overvoltage Reconnect Voltage;
- Low Voltage Reconnect Voltage > Low Voltage Disconnect Voltage \geq Discharge Limit Voltage;
- Undervoltage Alarm Recovery Voltage > Undervoltage Alarm Voltage \geq Discharge Limit Voltage;
- Boost Recovery Voltage > Low Voltage Reconnect Voltage.

3 Protection Features

No	Protection Features	Description
1	PV Overvoltage Protection	If the voltage at the photovoltaic array input exceeds the safe limit, the controller will automatically disconnect the photovoltaic input.
2	PV Reverse Polarity Protection	If the photovoltaic array is connected with reversed polarity, the controller will not be damaged. Once the wiring error is corrected, it will continue to operate normally.
3	PV Overpower Protection	When the power of the photovoltaic array exceeds the rated power, the controller will limit the charging power to within the rated range to prevent excessive current from damaging the controller. The controller will enter current-limiting charging mode.
4	Nighttime Reverse Charging Protection	Prevent the battery from discharging through the photovoltaic array at night.
5	Controller Overtemperature Protection	When the controller temperature exceeds the set threshold, the controller will reduce the charging power or stop charging.
6	Load Short Circuit Protection	In the event of a load short circuit, the controller will quickly disconnect the load. The user will need to manually reset the load short circuit fault.
7	Load Overload Protection	When the load exceeds the rated current, the load output will be turned off with a delay.
8	Battery Overvoltage/Overdischarge Protection	When overvoltage is detected in the battery, charging is immediately stopped. When battery overdischarge is detected, the load will be disconnected to stop discharging after a delay period.
9	Battery Reverse Connection Protection	The system will not operate if the battery is connected with reversed polarity, but the controller will not be damaged.
10	Battery Overtemperature Protection	When the battery temperature exceeds the set threshold, the controller will stop charging the battery and disconnect the load discharge.
11	TVS Surge Protection	

4 Product Installation

4.1 Product Dimensions

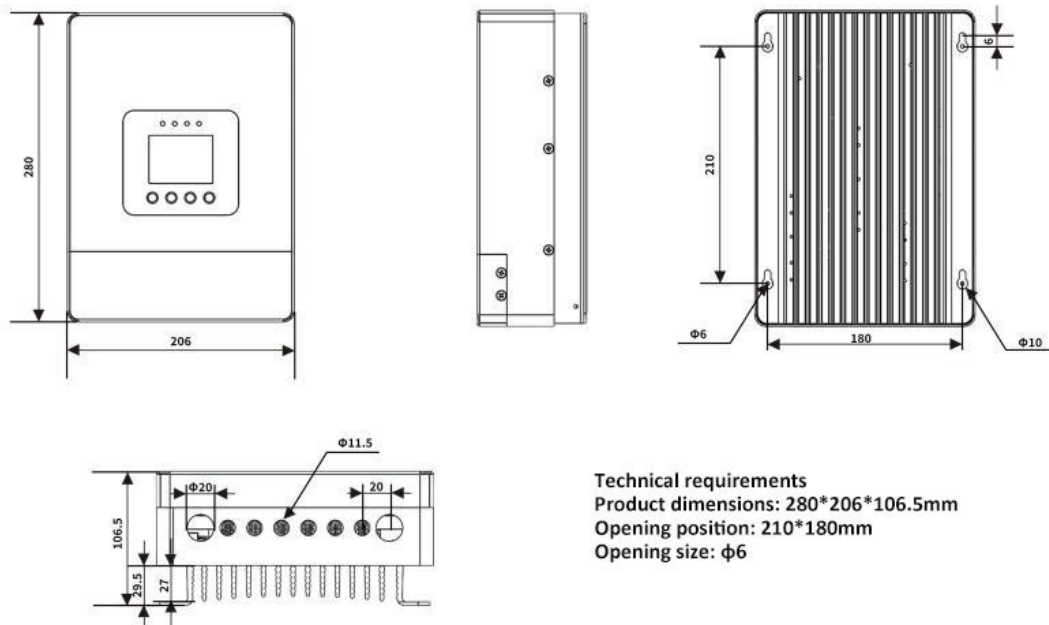

4.2 Precautions

- Be very careful when installing the battery. When installing open lead-acid batteries, wear safety goggles. If battery acid comes into contact with your skin or eyes, rinse immediately with clean water.
- Avoid placing metal objects near the battery to prevent short circuits.
- Charging the battery may produce acidic gases; ensure the surrounding environment is well-ventilated. The battery may also emit flammable gases, so keep it away from sparks.
- For outdoor installation, avoid direct sunlight and rainwater intrusion.
- Loose connections and corroded wires can generate excessive heat, melting the wire insulation, burning surrounding materials, and even causing a fire. Ensure all connections are tightened securely, and wires should be fixed with cable ties to prevent movement and loosening of connections during use.
- When connecting the system, the output voltage of the components may exceed the safe voltage for human contact. Use insulated tools during operation and ensure your hands are dry.
- The battery terminals on the controller can be connected to a single battery or a battery bank. The subsequent instructions in this manual are based on the use of a single battery but are also applicable to a battery bank system. Please follow the safety recommendations of the battery manufacturer.
- System connection wires should be selected based on a current density not exceeding 4A/mm².

- Ground the controller's grounding terminal.

4.3 Wiring Specifications

Wiring and installation methods must comply with national and local electrical codes and regulations.

The wiring specifications for the battery and load must be selected based on the rated current. Please refer to the table below for wiring specifications:

Model	Rated Charging Current	Rated Discharge Current	Battery Cable Gauge	Load Cable Gauge
GV200-60	60A	25A	>15mm ²	>8mm ²

4.4 Installation Steps

ⓘ Warning: Risk of Explosion! Never install the controller and open-type batteries in the same enclosed space! Also, avoid installing them in a confined area where battery gases may accumulate.

ⓘ Warning: High Voltage Hazard! The photovoltaic array may produce a high open-circuit voltage. Disconnect the circuit breaker or fuse before wiring, and exercise extreme caution during the wiring process.

⚠ Note: When installing the controller, ensure there is adequate airflow around the controller's heat sink. Leave at least 150mm of space above and below the controller to facilitate natural convection cooling. If installing in an enclosed box, ensure the box is designed for effective heat dissipation.

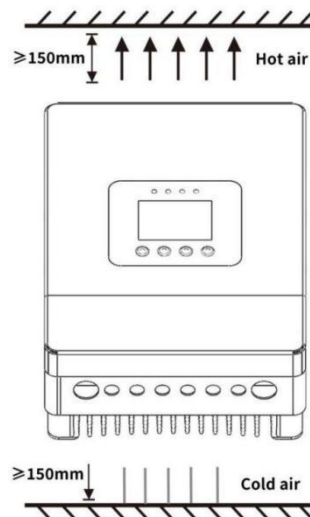

Figure 4.1 Installation and Cooling

Step 1: Choose the Installation Location

Avoid installing the controller in direct sunlight, high temperatures, or locations prone to water ingress. Ensure that the area around the controller is well-ventilated.

Step 2: Secure the Screws

According to the product's installation dimensions, mark the installation position with a pencil. Drill four appropriately sized holes at the marked locations,

then secure the screws in place.

Step 3: Secure the Controller

Align the controller's mounting holes with the four pre-installed screws, then hang the controller onto the screws.

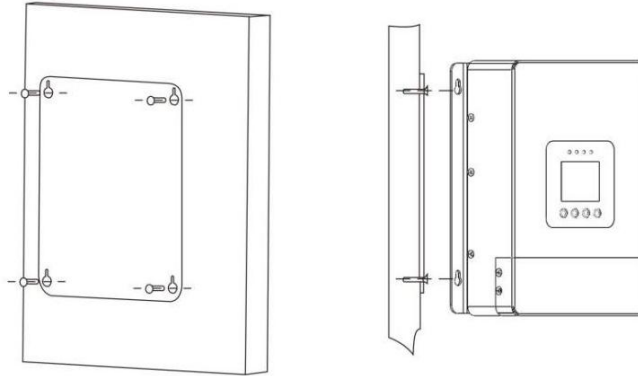

Figure 2.2: Securing the Controller

Step 4: Wiring

First, remove the two screws from the controller's front panel. Then, proceed with the wiring. For installation safety, we recommend following the wiring sequence indicated by the numbers in Figure 2.3. However, wiring in a different order will not damage the controller.

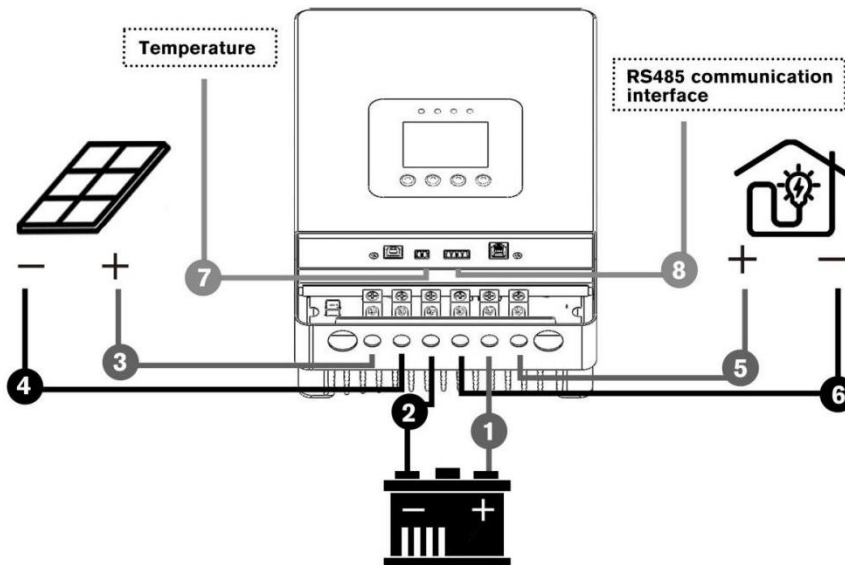

Figure 2.3: Wiring Sequence

- ① Connection of the External Temperature Sampling Interfac
- ② Connection of the Communication Cable
- ③ Connecting the Power Line

ⓘ Warning: Risk of Electric Shock! We strongly recommend installing fuses or circuit breakers on the photovoltaic array, load, and battery terminals to prevent the risk of electric shock during wiring or incorrect operation. Ensure that the fuses or circuit breakers are in the OFF position before making any connections.

ⓘ Warning: High Voltage Hazard! The photovoltaic array may generate very high open-circuit voltage. Ensure that the circuit breaker or fuse is disconnected before wiring, and exercise caution during the wiring process.

ⓘ **Warning: Risk of Explosion!** A short circuit between the positive and negative battery terminals or the wires connected to them can cause a fire or explosion. Handle with extreme caution. Connect the battery first, followed by the solar panels, and finally the load. When wiring, always connect the positive (“+”) terminal first, then the negative (“-”) terminal.

④ **Power On**

After all power lines are securely connected, double-check the wiring to ensure it is correct and that the positive and negative terminals are not reversed. Once verified, connect the battery fuse or circuit breaker first and observe if the LED indicator lights up and if the LCD screen displays information. If there is no display, immediately disconnect the fuse or circuit breaker and check if the wiring is correct.

If the battery powers up correctly, then connect the solar panels. If there is sufficient sunlight, the controller’ s charging indicator will either stay on or flash, indicating that it is charging the battery.

After the battery and solar panels are properly connected, connect the load fuse or circuit breaker last. At this point, you can use the manual mode to test whether the load turns on and off normally. Refer to the load operation mode and instructions for details.

ⓘ **Warning:** Disconnecting the battery while the controller is in normal charging mode may adversely affect the DC load connected to the controller and, in severe cases, could damage the load.

⚠ Ensure that the battery fuse is installed as close to the controller as possible, with a recommended installation distance of no more than 150 mm.

⚠ **Note:**

- 1) If the temperature sensor is not connected, the controller will default to a fixed battery temperature of 25° C.
- 2) If an inverter is included in the system, connect it directly to the battery. Do not connect it to the load terminal of the controller.

5 Interface Operation

5.1 LED Indicators

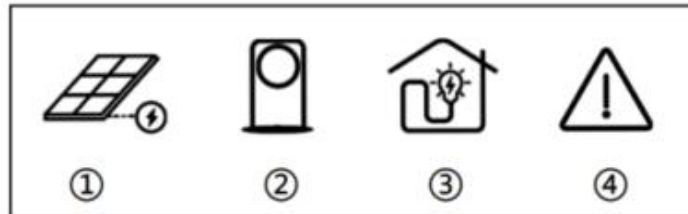

①--- PV Array Indicator	PV Status
②--- BAT Indicator	Battery Status
③--- LOAD Indicator	Load Status
④--- ERROR Indicator	Fault Status

PV Array Indicator

Indicator Status	PV Status
Constantly On	PV Voltage Normal
Off	PV Voltage Low or Not Connected

BAT Indicator

Indicator Status	Battery Status
Constantly On	Battery Voltage Normal
Flashing	Charging
Off	Battery Not Connected

Load Status

Indicator Status	Load Status
Off	Load Off
Constantly On	Load Operating Normally

ERROR 指示

Indicator Status	Fault Status
Off	System Operating Normally
Constantly On	System Anomaly

5.2 Button Operation

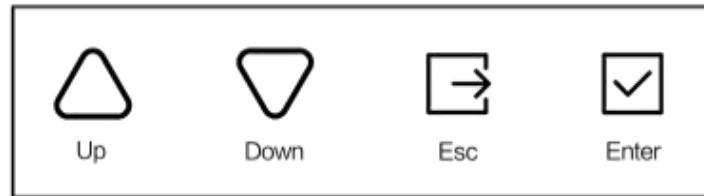

△	Menu Up/Menu Left/Increase Parameter
▽	Menu Down/Menu Right/Decrease Parameter
→	Return to Previous Menu, Exit Without Saving
☑	Enter Submenu; Settings

5.3 LCD Display and Operation

5.3.1 Main Page

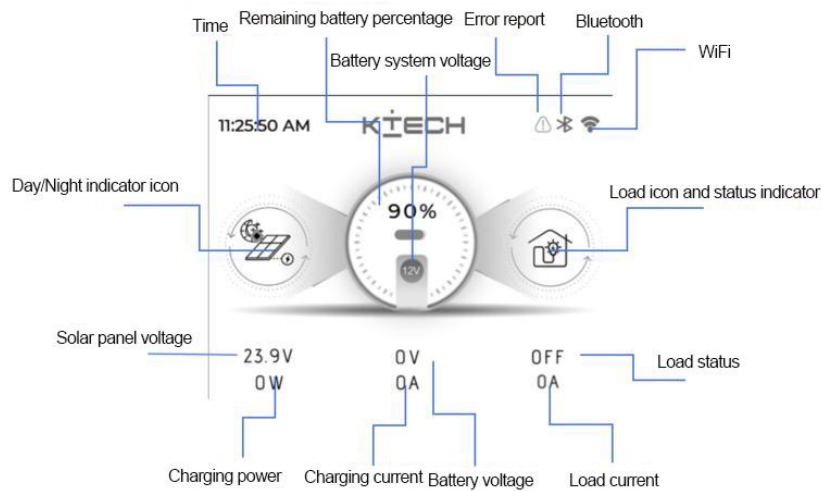

Main Page Icon Reference Table

Icons or Data	Status	Description	Note
	Always On	Night	Charging Related
	Always On	Day	

	Always On	The beam icon indicates dynamic display during charging. If the beam is not present, it means not charging.	
	12V	Current Battery Voltage is 12V System	Battery Related
	24V	Current Battery System is 24V	
	36V	Current Battery System is 36V	
	48V	Current Battery System is 48V	
	Always On	The beam icon indicates that the load is on, while its absence indicates that the load is off.	Load Related

5.3.2 Main Menu









In the 'Main Interface,' press to access the Main Menu. In this menu page, press and , to switch between menu options. Press to return to the 'Main Interface.'

Menu Level	Item	LCD Display Item
Main Menu	1. Real-time Monitoring	Realtime Monitor
	2. Parameter Settings	Parameter Settings
	3. Event Log	Event Logging
	4. Historical Data	Historical Data
	5. Statistics	Statistical Data
	6. Device Information	Device information

5.3.3 Realtime Monitor

This menu contains and supplements the information in the Main Menu.

“In the ‘Main Menu,’ press ‘ ’, to select the ‘Real-time Monitoring’ option. Press ‘’ to enter Real-time Monitoring. In this menu page, press ‘’, and ‘’, to navigate left and right. Press ‘’, to return to the ‘Main Menu.’”

Menu Level	Page Number	Item	LCD Display Item	Description	
Secondary Menu	1	Charging Status Indicator	Chag State	Charging Status Indicator: "IDLE", Not Charging "MPPT", MPPT Charging "EQU", Equalization Charging "BST", Boost Charging "FLT", Float Charging "LIMIT", Current-limited Charging	
		Solar Panel Voltage	PV voltage	0V	
		Battery Voltage	Battery voltage	11.6V	
		Charging Current	Charge current	0A	
		Charging Power	Charge Power	0W	
		Battery Remaining Capacity	Battery Soc	100%	
	1	2	Load Status	LoadState	OFF
			Load Current	LoadCrt	0A
			Discharge Power	Discharge power	0W
			Device Temperature	Device temperature	27° C
			Battery Temperature	Battery temperature	27° C
			Error code	Error code	Fault Code: Fault Cause 0 "NO-ERROR" No Fault 1 "BAT-UNDERVOLTAGE" Battery Over-discharge 2 "BAT-OVERVOLTAGE" Battery Overvoltage 3 "BAT-UDV-WARNING" Battery Under-voltage Warning 4 "LOAD-SHORTCIRCUIT" Load Short Circuit 5 "LOAD-OVERCURRENT" Load Overcurrent 6 "DEVICE-OVERTEMP" Internal Device Overtemperature 7 "BAT-OVRTMP" Battery Over-Temperature



				8 "PV-OVERPOWER" Solar Panel Over-Power
				9 "PV-OVERVOLTAGE" Solar Panel Open-Circuit Overvoltage
				10 "PV-REVERSE" Solar Panel Reverse Polarity
				11 "BAT-REVERSE" Battery Reverse Polarity
				12 "BAT-UNDER-LIMIT" Battery Voltage Below Discharge Limit Voltage

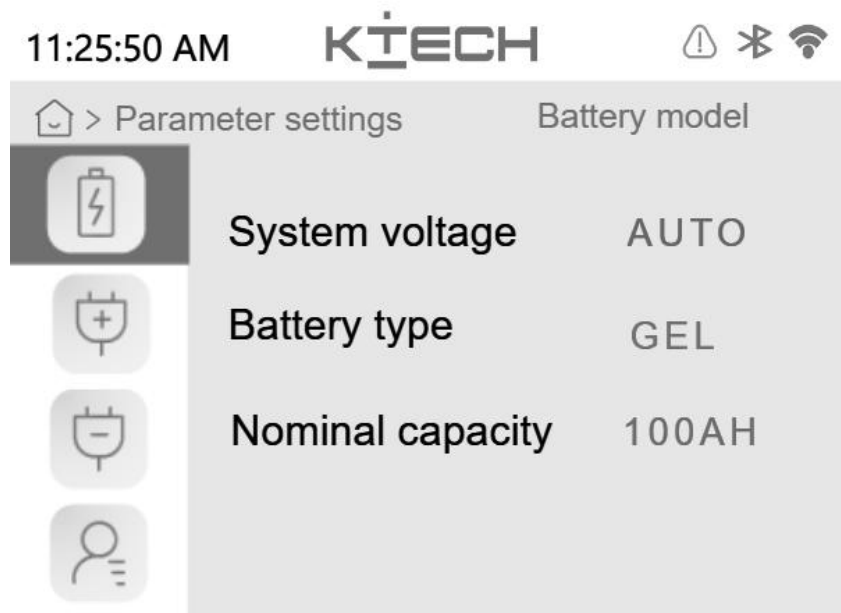

After a fault code pop-up appears on the interface, once the issue has been resolved, press and hold the " " to reset and clear the pop-up.

5.3.4 Parameter Settings



Item	Item Icon	Item Name	LCD Display Item	Item Parameters and Range	Step Size
1. Battery Settings		Battery System Voltage	System voltage: 12V	"AUTO" "12V" "24V" "36V" "48V"	
		Battery Type	Battery type :SLD	"SLD" Sealed Lead-Acid Battery "FLD" Flooded Lead-Acid Battery "GEL" Gel Battery "LI" Lithium Battery	

				"USE" User Defined	
		Battery Nominal Capacity	Nominal capacity: 100AH	×1 (1~9999AH)	1
2. Battery Charging Parameters		Charging Limit Voltage	OV threshold: 16V	×0.1V (9.0~17.0V) * n	0.1
		Equalization Charging Voltage	Equalizing voltage: 15.6V	×0.1V (9.0~17.0V) * n	0.1
		Boost Charging Voltage	Boost voltage: 14.4V	×0.1V (9.0~17.0V) * n	0.1
		Float Charging Voltage	Floating voltage: 13.8V	×0.1V (9.0~17.0V) * n	0.1
		Boost Charging Return Voltage	Boost restore: 13.2V	×0.1V (9.0~17.0V) * n	0.1
		Equalization Charging Time	Equalizing duration: 120min	×1MIN (0~300 MIN)	1
		Boost Charging Time	Boost duration: 120min	×1MIN (0~300 MIN)	1
		Equalization Charging Interval	Equalizing interval: 30day	×1D (0, Close; 1~300D(days))	1
		Temperature Compensation	Temperature comp: -3.0mV	×-0.1mV (0, No Compensation; -(3~5)mV/°C/2V)	0.1
		Maximum Charging Current Setting	Max charge current: 60A	×1 (0~60A: 0: Disable System Charging and Discharging)	1
		Charging Activation Method	Active type :PULSE	×1 (0, OFF: Disable Activation (Lead-Acid Batteries Only); 1. PULSE: (Default) Intermittent Control (except for Lead-Acid Batteries); 2. CV: Constant Voltage Mode Control (except for Lead-Acid Batteries))	
3. Battery Discharge Parameters		Discharge Return Voltage	Disconnect restore: 12.6V	×0.1V (9.0~17.0V) * n	0.1
		Under-Voltage Warning Voltage	Under vol warning: 12.0V	×0.1V (9.0~17.0V) * n	0.1
		Discharge Voltage	Disconnect voltage: 11.1V	×0.1V (9.0~17.0V) * n	0.1
		Discharge Limit Voltage	Discharging limit: 10.6V	×0.1V (9.0~17.0V) * n	0.1
		Over-Discharge	Overdischarge delay:	×1s (0~60s)	1

		Delay Time	5s		
4. Load Control		Load Mode	Load mode : Normal on	×1 (0: Always On; 1: Pure Light Control; 2: Light Time Control; 3: Manual Mode; 4: Debug Mode)	
		Control Voltage	Control voltage: 10 V	×1V (5~11V) * n	1
		Delay Control	Control delay: 0 MIN	×1MIN (0~60MIN)	1
		Working Time	Working time: 1 HOUR	×1H (1~14Hour)	1
		Short Circuit Protection	Short circuit: ON	×1 (0: Disabled; 1: Enabled)	
5. Communication		Address	Adress :1	×1 (1~247)	1
		RS485 Communication Mode: Master/Slave	RS485 Mode: Slave	×1 (0, Modbus Slave; 1, BMS Master)	
		Baud Rate	RS485 Baud: 9600	×1 (0, 9600; 1, 19200; 2, 38400; 3, 57600; 4, 115200)	
		RS485 Parity	RS485 Parity: N	×1 (0, None; 2, Even; 3, Odd)	
		RS485 Data Bits	RS485 Data bits: 8	×1 (0, 5; 1, 6; 2, 7; 3, 8)	
		RS485 Stop Bits	RS485 Stop bits: 1	×1 (1, 1; 2, 1.5; 3, 2)	
		RS232 Communication Mode: Master/Slave	RS232 Mode: Slave	×1 (0, Modbus Slave; 1, BMS Master)	
		Baud Rate	RS232 Baud: 9600	×1 (0, 9600; 1, 19200; 2, 38400; 3, 57600; 4, 115200)	
		RS232 Parity	RS232 Parity: N	×1 (0, None; 2, Even; 3, Odd)	
		RS232 Data Bits	RS232 Data bits: 8	×1 (0, 5; 1, 6; 2, 7; 3, 8)	
		RS232 Stop Bits	RS232 Stop bits: 1	×1 (1, 1; 2, 1.5; 3, 2)	
		Bluetooth	Bluetooth: ON	×1 (0, Disabled; 1, Enabled)	
		Wi-Fi	WIFI: ON	×1 (0, Disabled; 1, Enabled)	
		6. System Settings		Backlight Time	Backlight: 600s
Restore Factory Settings	Restore factory settings			Selecting 'YES' Activates	

Note: The value of n can be 1, 2, 3, or 4, representing 12V, 24V, 36V, or 48V battery systems, respectively.

In load control, when the load mode is set to "Manual Mode," press and hold the " \triangle " to turn the load output on or off.

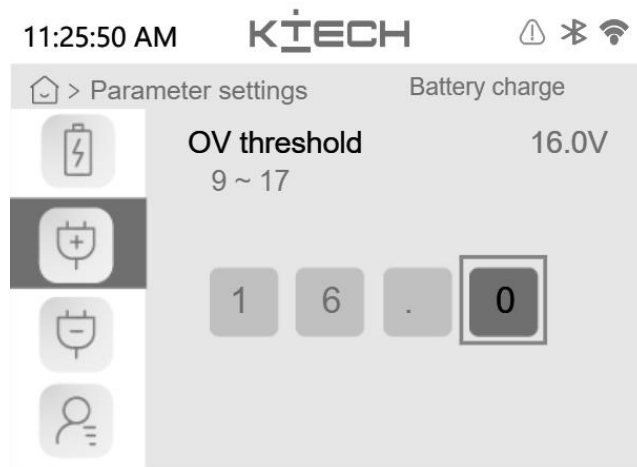

In the 'Parameter Settings' menu, press ' \triangle ', ' ∇ ' to select the desired item. Press ' \square ' to enter the corresponding item, use ' \triangle ' to select the digit, and ' ∇ ' to adjust the parameter. Press ' \square ' to confirm and save, or press ' \rightarrow ' to exit without saving.

5.3.5 Event Logging

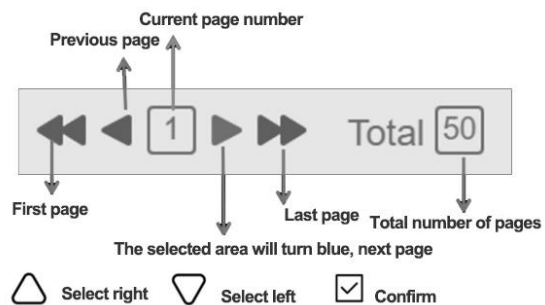
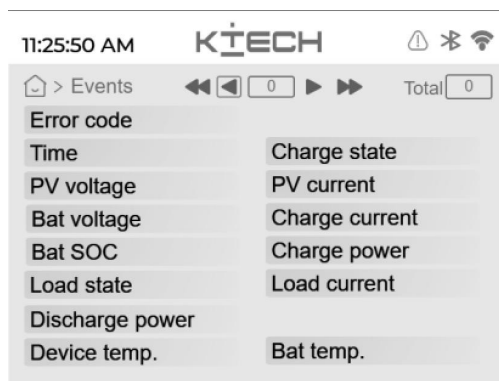

Up to 256 events can be recorded.

LCD Display Item	Description
Error code	Error Code
Time	Occurrence Time
PV voltage	Solar Panel Voltage
Bat voltage	Battery Voltage

Bat SOC	Battery Remaining Capacity
Load state	Load Status
Discharge power	Discharge Power
Device temp	Device Temperature
Charge state	Charging Status
PV current	Solar Panel Current
Charge current	Charging Current
Charge power	Charging Power
Load current	Load Current
Bat temp	Battery Temperature

5.3.6 Historical Data

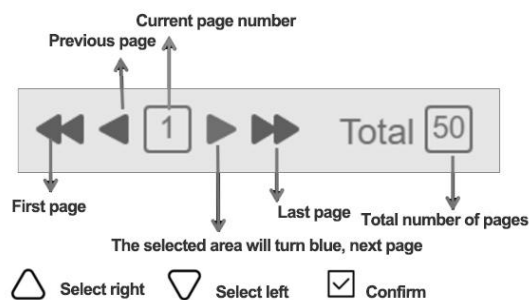

Up to 1024 days of historical data can be recorded, where '0 day' represents the current day's data, '1' represents data from the previous day, 'n' represents data from n days prior, and so on.

LCD Display Item	Description
Bat voltage min	Minimum Battery Voltage
Bat voltage max	Maximum Battery Voltage
Charge current max	Maximum Charging Current
Discharge current max	Maximum Discharging Current
Charge power max	Maximum Charging Power

Discharge power max	Maximum Discharging Power
Charge Ah	Charging Current
Discharge Ah	Discharging Current
Power gen	Power Generation
Power usage	Power Consumption

5.3.7 Statistical Data

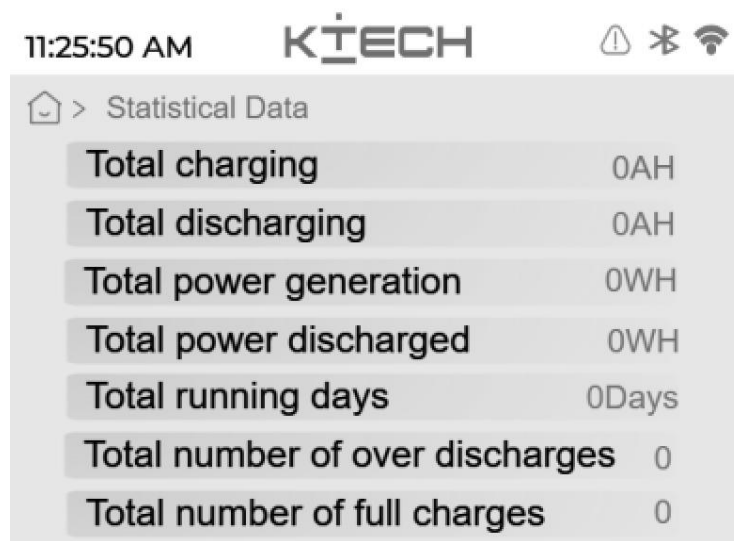

LCD Display Item	Description
Total charging	Total Charging Amount
Total discharging	Total Discharging Amount
Total power generation	Total Charging Power
Total power discharged	Total Discharging Power
Total running days	Total Operating Days
Total number of over discharges	Total Over-Discharge Count
Total number of full charges	Total Power Generation

5.3.8 Device Information



LCD Display Item		Description
Model		Model
Serial	Serial number	Serial Number
Hardware version		Hardware Version
Software version		Software Version

Adjust Device Time:

In the Device Information screen, press '△' and '▽' to select 'Set Time'. Press '☑' to enter that screen. Press '△' and '▽' to select the date to be adjusted. Press '☑' to adjust the numbers. After adjusting the data, press '△' and '▽' to select 'Submit', then press '☑' to confirm and save. Press '☞' to exit without saving.

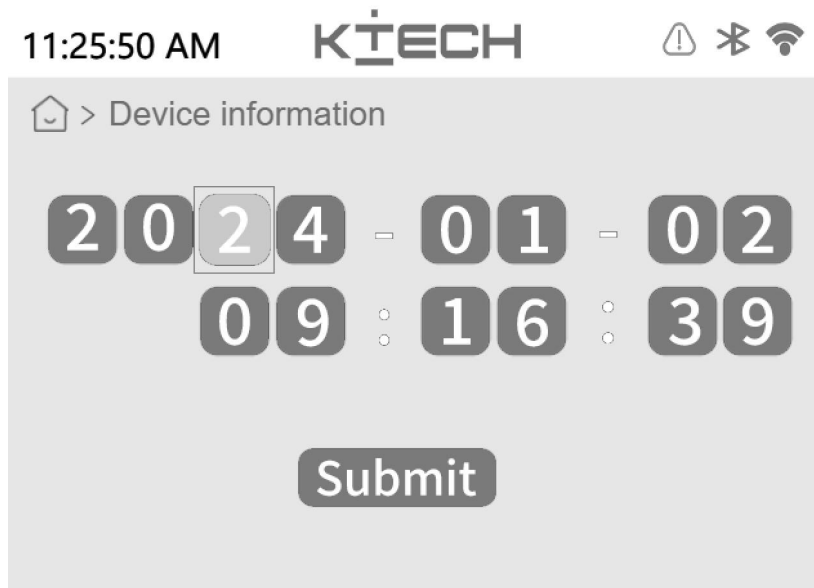

Clear Event Records:

In the Device Information screen, press ' \triangle ' and ' ∇ ' to select 'Clear Events'. After pressing '' , a dialog box will pop up with 'Sure to clear events'. Press '' again, and the system will clear the event records.

Clear Historical Data:

In the Device Information screen, press ' \triangle ' and ' ∇ ' to select 'Clear History'. After pressing '' , a dialog box will pop up with 'Sure to clear history data'. Press '' again, and the system will clear the historical data.

6 System Maintenance

- To maintain optimal performance, it is recommended to inspect the system at least twice a year.
- Ensure that airflow around the controller is not obstructed, and remove any dirt or debris from the heatsink.
- Check all exposed wires for damage to insulation caused by sun exposure, friction with surrounding objects, decay, insect or rodent damage. Repair or replace wires as necessary.
- Verify that indicator lights match the device's operation. Pay attention to any faults or error displays and take corrective actions if needed.
- Inspect all terminal connections for signs of corrosion, insulation damage, high temperatures, or burning/discoloration. Tighten terminal screws.
- Check for dirt, nesting insects, and corrosion, and clean as required.
- If the surge protector is faulty, replace it promptly to prevent damage to the controller or other equipment from lightning strikes.

ⓘ Warning: Risk of Electric Shock! Ensure that all power sources to the controller are disconnected before performing any inspections or operations!